

Learn from the mistakes of others; you'll not live long enough to make them all yourself . . . **Issue 2/2004**

When Things Aren't...

When things aren't running as they normally do, the level of risk is usually higher. This, in turn, means extraordinary vigilance must be applied. Case in point: in October 2000, a Boeing 747 crashed shortly after lifting off from Taipei, Taiwan, killing all onboard. The crew had been cleared for a Runway 05 left (05L) departure because Runway 05 right (05R) was closed due to construction. After reaching the end of a parallel taxiway, the crew turned the aircraft immediately to Runway 05R. After a short hold, it started its take-off roll. A few seconds after reaching decision speed (V1), the aircraft hit concrete barriers and construction equipment on the runway. The plane crashed back onto the runway, breaking up and bursting into flames.

Conditions on that day were anything but normal. A NOTAM had been issued, indicating that part of Runway 05R was closed for construction. Heavy rain and strong winds from a typhoon prevailed, affecting visibility. Moderate time pressure to take off before the inbound typhoon closed-in around the airport may have influenced the flight crew's decision making and ability to maintain situational awareness. In the end, the flight crew lost situational awareness and took off from the wrong runway.

Airport maintenance and construction are unavoidable and necessary, which means Canadian airports are also affected. On November 20, 2002, a Shorts SD 360 was on final approach to Runway 12 at the Vancouver International Airport, British Columbia, at the same time as a Boeing 747-400 bound for Japan began its take-off roll from Runway 26R. Large aircraft rarely take off from Runway 26R at Vancouver, but there was a construction project going on, and two cranes were set up beyond the departure end of Runway 26L, the usual take-off runway for large aircraft at Vancouver. The "unusual" circumstances were set, the first link in the accident chain. The chain was luckily broken, as it most often is; however, there remained a serious risk of collision, when the Shorts SD 360 crossed 0.5 nautical miles (NM) in front of and 100 ft below the Boeing 747-400. The following synopsis is based on the Transportation Safety Board of Canada (TSB) Final Report A02P0299.



Artist's impression of the risk of collision.

A NAV CANADA *Operations Bulletin* described the construction project and included air traffic control (ATC) operating limitations. When aircraft were too heavy to use Runway 26L for departure with the cranes operating, these aircraft would be allowed to use Runway 26R. No guidelines were issued for the coordination and use of Runway 12 when Runway 26R was being used for departures. During the incident, the Vancouver Tower was staffed with five controllers: tower south, ground south, tower advisory, clearance delivery, and the combined tower north and ground north.

At 11:29 local time, Runways 26R and 26L became the active runways. With Runway 12 already active, three runways were in use at the time of the incident. The tower south controller controlled Runway 26L (the primary runway used for departing and some arriving aircraft) and Runway 12 (used for arrivals). The tower north controller controlled Runway 26R, normally used for arriving aircraft only. However, as a result of the two cranes beyond the departure end of

Runway 26L, some large aircraft were authorized to depart from Runway 26R, under specified conditions.

The tower advisory controller cleared the Shorts crew for the Point Grey arrival for Runway 12 and issued traffic information—a DHC-8 ahead, on a visual approach for Runway 12. The crew was instructed to follow the traffic. He then instructed the crew to contact the tower south controller at Point Grey. There was no coordination between the tower advisory controller and the tower north controller for Runway 12 arrivals: local procedures did not require such coordination.

At 11:52, the tower south controller cleared the Shorts to land on Runway 12 and to hold short of Runway 26L. No information was given to the crew of the Shorts about the departure of the 747 from Runway 26R. At 11:36, the tower north controller advised the 747 crew that their departure runway would be Runway 26L. On being advised of the cranes operating off the end of Runway 26L, the pilot requested and received a taxi clearance for a departure from Runway 26R.

After clearing the 747 to taxi for Runway 26R, the tower north controller walked across the tower cab to the tower south location and advised the tower south controller that there would be a departure from Runway 26R in about 5 min. The tower south controller indicated that there was traffic for Runway 12 but did not mention any specific flights. At the time, the Shorts was about a 6 mi. behind a DHC-8; the Shorts was not within the range selected on the tower south controller's radar display and was still on the tower advisory controller's frequency.

The tower north controller was aware of a DHC-8 on approach for Runway 12, because this flight was showing on his radar display as a correlated target with flight number, altitude, and speed. Behind the DHC-8, he saw another radar target with a triangular target symbol, showing only a limited data block (altitude and speed display, but no flight number). The tower south controller had not made specific reference to a second aircraft on approach, and the tower north controller concluded that this second aircraft was not on approach to Runway 12.

At 11:51, the tower north controller authorized the 747 to taxi to position and wait on Runway 26R. Thirty seconds later, he cleared the 747 for takeoff from Runway 26R. At the time, the Shorts was 3.1 NM northwest of the departure path for Runway 26R. The tower north controller did not inform the tower south controller that he had cleared the 747 for takeoff.

While the 747 was still on the take-off roll, the tower north controller saw an aircraft inbound from the northwest. He queried the tower south controller, who advised that it was the Shorts aircraft inbound for Runway 12. The tower north controller recommended instructing the inbound aircraft to keep the speed up, because it now appeared that the inbound aircraft would cross the departure path of Runway 26R ahead of the 747.

At 11:53, the tower south controller advised the crew of the Shorts to keep the speed up and that there was traffic rolling on Runway 26R. Both pilots of the Shorts observed the Boeing 747 coming toward

them and just lifting off Runway 26R. They immediately banked the aircraft to the right, increased the rate of descent and increased the engine power settings. (*In other words, they took EVASIVE ACTION... —Ed.*)

As soon as the pilots observed that they were clear of the departing traffic, they turned toward Runway 12 again and landed the aircraft without further incident. The Shorts had crossed the Runway 26R departure path 0.5 NM in front of and about 100 ft below the take-off profile of the departing 747. There was no indication that the crew of the 747 saw the other aircraft.

The NAV CANADA *Air Traffic Control Manual of Operations* states that controllers shall “maintain close coordination at all times between positions of operation within ATC units and between these positions and other ATC units, Flight Service Stations [FSS], and other concerned agencies.” It further specifies that controllers shall “separate a departing aircraft from an aircraft using...a non-intersecting runway if flight paths intersect by ensuring that the departing aircraft does not begin its take-off roll until...a preceding arriving aircraft has crossed over the departure runway.” The NAV CANADA *Air Traffic Services Administration and Management Manual* states that managers are responsible for issuing “direction and information required for the efficient administration and operation of the unit in the form of an operations letter, for long term items related to the provision of air traffic services (e.g. control, coordination, communication...)” No specific guidance was published to guide Vancouver Tower controllers on procedures to follow when using Runway 26R for departures.

The radar display showed a small triangle for the target symbol for the Shorts, and a limited data block associated with the radar target, because the target was not correlated with any flight plan information stored in the ATC computer system. The tower advisory procedures do not require the controller to manually add the aircraft's flight number to the inbound aircraft's radar target to create a full data block.

Analysis—Runway 26R was rarely used to depart aircraft. The initial coordination between the tower north and tower south controllers was deficient in the areas of specific traffic information and follow-up coordination prior to the departure of the 747. Neither controller ensured that the other had the complete traffic picture. Since the arrival flight path for Runway 12 and the departure flight path for Runway 26R intersect, and operations on these runways are controlled by different controllers, the tower north and tower south controllers both had the responsibility to ensure that the complete traffic picture was relayed to the other. The coordination between the tower north and tower south controllers was not completed in a manner sufficient to prevent a risk of collision between two aircraft.

Because of equipment reconfiguration activities in the Vancouver Tower, the tower advisory controller happened to be sitting next to the tower north controller in the time leading up to the incident and knew of arriving traffic to Runway 12 that would



The Aviation Safety Letter is published quarterly by Civil Aviation, Transport Canada, and is distributed to all Canadian licensed pilots. The contents do not necessarily reflect official policy and, unless stated, should not be construed as regulations or directives. Letters with comments and suggestions are invited. Correspondents should provide name, address and telephone number. The ASL reserves the right to edit all published articles. Name and address will be withheld from publication at the writer's request.

Address correspondence to: Editor, Paul Marquis

Aviation Safety Letter
Transport Canada (AARQ)
Ottawa ON K1A 0N8
Tel.: 613 990-1289
Fax: 613 991-4280
E-mail: marqupj@tc.gc.ca
Internet: www.tc.gc.ca/ASL-SAN

Reprints are encouraged, but credit must be given to the ASL. Please forward one copy of the reprinted article to the Editor.



Paul Marquis

Regional System Safety Offices

- Atlantic: Box 42, Moncton NB E1C 8K6, 506 851-7110
Quebec: 700 Leigh Capreol, Dorval QC H4Y 1G7, 514 633-3249
Ontario: 4900 Yonge St., Suite 300, Toronto ON M2N 6A5, 416 952-0175
Prairie & Northern: Box 8550, 344 Edmonton St., Winnipeg MB R3C 0P6, 204 983-5870; Canada Place, 1100-9700 Jasper Ave., Edmonton AB T5J 4E6, 780 495-3861
Pacific: 3600 Lysander Lane, Richmond BC V7B 1C3, 604 666-9517

Sécurité aérienne — Nouvelles est la version française de cette publication.

Agreement Number 40063845

have been of use to the tower north controller. The tower advisory controller coordinated primarily with the tower south controller for Runway 12 arrivals and overflights and did not normally bring the tower north controller into the information loop.

The two Operations Bulletins were silent on coordination requirements for an unusual situation such as a Runway 26R departure during the construction near Runway 26L. Controllers were left to rely on their own experience and judgement to ensure safe and efficient operations. Several factors resulted in both controllers having deficient situational awareness: the lack of specific guidance material for managing departures from Runway 26R; the imprecise and incomplete coordination of relevant traffic; and an assumption by both controllers that the other knew what was going on. These factors resulted in a take off clearance being given to the 747 at the same time that the Shorts had a clearance to land on Runway 12, without any form of separation being applied.

The limited data block on the radar displays in the Vancouver Tower resulted in a misinterpretation of the information relating to the Shorts. No procedures require airport controllers to add aircraft identification or intention onto the radar-displayed targets of aircraft under their control. It may therefore be more difficult to distinguish arrivals to the airport from transiting traffic, reducing controllers' situational awareness about some of the aircraft operating within their airspace.

Among its findings, the TSB determined that neither the tower north controller nor the tower south controller fully coordinated the departure of the Boeing 747-400 from Runway 26R and the arrival of the Shorts SD 360 on Runway 12, and that on being informed of a pending departure from Runway 26R, the tower south controller did not advise the tower north controller of all the pertinent traffic arriving for Runway 12.

Safety Action—The day following the occurrence, an Operations Bulletin was disseminated, stipulating that: "when Runway 26R is used for departures during the Bypass Pier Construction Project...the use of Runway 12 for arrivals shall be discontinued." In addition, effective March 1, 2003, a change to Vancouver Tower Class C airspace procedures required all arriving and departing VFR aircraft to obtain discreet transponder codes. This change allows aircraft tracked by radar to be correlated with flight plan information, including flight number or aircraft registration, and, thereby, be more conspicuous on the radar display.

Readers are encouraged to obtain a copy of this Final Report from the TSB. When complex operations are further complicated by unusual circumstances, such as construction sites, realize that the risk level grows significantly. —Ed. △

IN THIS ISSUE

Table with 2 columns: Article Title and Page. Includes items like 'When Things Aren't...', 'From The Investigator's Desk: Navigational Error—Convair 580', 'Weight and Balance of Aircraft', etc.

From The Investigator's Desk: Navigational Error—Convair 580

An Aviation Safety Advisory from the Transportation Safety Board of Canada (TSB)

On 18 June 2003, while on a ferry flight to New Zealand, a Convair 580 aircraft inadvertently deviated substantially to the east of its track and the crew became lost. Two global positioning systems (GPS) were in use as the sole source of navigation. The aircraft was located and provided with navigational assistance by a United States Air Force (USAF) C-141 aircraft. While the aircraft landed safely in Gisborne, N. Z., only about 359 lbs of fuel remained, sufficient for only a few minutes of flight. The investigation (A03F0114) is ongoing.

In accordance with standard aviation safety procedures and practices, the *Company Operations Manual (COM) Section 3 A—International Long Range Procedures* contains procedures to be utilized when conducting operations in oceanic airspace.

Section 3 A.2.1—*Pre-flight*, mandates in part that during the pre-flight check of the long range navigation system (LRNS) the flight crew shall enter and confirm the planned route of flight. The section goes on to state:

“If not stored as a standard route, waypoints for Operational Flight Plan (OFP) route must be entered into the GPS. Whether stored or not, both the pilot flying (PF) and pilot not flying (PNF) will verify the entered route during the pre-flight checks prior to departure confirming both waypoint designator and LAT/LONG of the waypoint.”

COM Section 3 A.2.3—*Waypoint Passage*, mandates in part that approaching each en route waypoint the crew shall verify present position and confirm next waypoint, desired track, and distance.

The investigation to date has revealed that the last six waypoints of the last leg had been entered with west longitude coordinates, instead of the correct east longitude coordinates. For the three legs between Canada and New Zealand, none of the waypoints as entered in the two GPS were verified against the computer-generated flight plan. The bearings and distances between waypoints were not checked either. The incorrect entries remained undetected until the flight path substantially deviated and the crew became lost.

A search of the TSB Aviation Safety Information System (ASIS) database revealed 174 instances of navigational errors between 1 January 1980 and 1 November 2003, of which 18 involved confirmed and 20 involved suspected data entry errors into LRNS.

Although the aircraft landed safely, the fact that the crew did not detect the waypoint position errors resulted in the fuel being almost totally exhausted and there was a potential for serious injury to the crew members. Historical data indicates this is not an isolated occurrence of this type. The procedure in the COM requiring cross checking of GPS data against hard copy flight plan data provided a defence against the risk of the crew failing to detect GPS data entry errors. Unfortunately, this defence was not used.

The advisory letter concluded by suggesting that Transport Canada (TC) may wish to use this occurrence to remind flight crews of the risks of not verifying waypoint data when using navigation equipment such as GPS.

In its response to the advisory, TC stated that it believes that the regulatory provisions relating to long range navigation are adequate and that if the flight crew in this instance had followed their company's Operations Manual (OM), the error would have been detected and corrected. TC also believes that safety education and promoting adherence to Standard Operating Procedures (SOP) will be more effective than regulatory action in reducing the risks associated with navigational data entry. To this end, this Aviation Safety Advisory is the subject of this article in the *Aviation Safety Letter*. Later this year, TC will consider the need for further promotional activity. △



Seems like we're not getting any closer to New Zealand... did we enter the right numbers?

Weight and Balance of Aircraft

Weight and balance factors are critical to the safe operation of an aircraft. Weight and balance refer to the weight of an aircraft and the location of the centre of gravity. Aircraft are designed to operate within certain weight and balance limits.

Air operators must comply with Transport Canada weight and balance requirements for safe takeoffs and landings, as well as for maintaining control of the aircraft during flight. The *Canadian Aviation Regulations* (CARs) prohibit an air operator from flying an aircraft unless, during every phase of flight, the load restrictions and weight and balance of the aircraft conform to the limitations specified in the approved aircraft flight manual.

In addition, there are strict regulations that require an air operator to have a Transport Canada-approved weight and balance system in place. Safety regulations require mandatory training for all air operator personnel and instructions to employees regarding the preparation and accuracy of weight and balance forms, to be filled out prior to takeoff, as well as detailed instructions on how to weigh and balance an aircraft. These regulations address items such as:

- weight of passengers, carry-on baggage and checked baggage;
- weight of the fuel load; and
- balanced distribution of aircraft load.

Air operators have several options approved by Transport Canada to calculate passenger weight, such as weighing each passenger getting on-board, using statistical survey weights, or using Transport Canada's approved weight standards.

The current Transport Canada's passenger weight standards are:

- males—summer 182 lbs, winter 188 lbs;
- females—summer 135 lbs, winter 141 lbs;
- children (2–11 years)—summer 75 lbs, winter 75 lbs;
- infants (0–less than 2 years)—summer 30 lbs, winter 30 lbs; and
- animals—the actual weights of the animals are used.

Air operators and pilots are required to ensure that the aircraft weight and balance remain within approved limits and to ensure that for instance, heavy-set individuals are accounted for accurately in the total passenger weight.

Transport Canada enforces compliance of regulatory requirements for weight and balance systems through a number of means, such as a comprehensive monitoring, inspections and audit program. Inspectors from the department will also conduct unannounced, on-the-field inspection to verify weight and balance. Should Transport Canada identify an air operator who does not comply, the department will take appropriate enforcement action. This action can range from a warning or monetary fines, to the suspension of licenses and air operator certificates.

Transport Canada continues to raise awareness within the civil aviation community on the safety consequences of flying an improperly loaded aircraft by publishing articles in safety publications and by conducting safety workshops across Canada every year.

More information on *Commercial Air Service Standards* and on weight and balance of aircraft is available at www.tc.gc.ca/civilaviation/Regserv/Affairs/cars/Part7/menu.htm. △

Locating Aircraft in Case of Emergency

New 406 MHz Emergency Locator Transmitters (ELTs)

Reprinted from R&D Update, Transportation Development Centre (TDC), November 2003 (TP 10913)

To alert search and rescue authorities of the location of a downed plane, most Canadian aircraft are required to carry ELTs that automatically send a radio signal that can be detected by a satellite.

The first generation of these beacons operated at 121.5 MHz and has been responsible for saving thousands of lives around the world since the very first rescue in British Columbia in 1982. However, these beacons also suffered from a serious problem of false alarms. A new generation of more reliable ELTs that operate at 406 MHz offers far superior search and rescue response. The beacons are more readily detected by satellites, transmit codes that identify each beacon and its owner, and allow the origin of the signal to be detected to within a radius of between two and five kilometres.

Changing the satellite network

COSPAS-SARSAT, the international satellite search and rescue network, has announced that as of

2009, it will no longer recognize signals from 121.5 MHz ELTs.

At the same time, regulators such as Transport Canada have been reluctant to order the general aviation community to switch to 406 MHz ELTs because the significantly higher cost may deter small aircraft owners from buying one. While 121.5 MHz beacons sell for under \$1 500, 406 MHz beacons currently on the market can cost as much as \$3 500.

Off-the-shelf components

With support from the National Search and Rescue Secretariat's New Initiatives Fund, research coordinated by TDC found that a much less expensive 406 MHz ELT beacon was feasible using off-the-shelf components and a simplified design. Design work included the development of miniaturized electronics, power sources, and reliable activation devices, as well as component and packaging design that complies with civil aviation

regulations and that can withstand a harsh operating environment. The new ELT features a lithium battery, specially designed signal amplifiers, and an automatic gain control circuit. A working prototype has been constructed and work is underway on the production engineering, which is expected to bring the cost down within the same range as 121.5 MHz beacons.

The prototype was certified by COSPAS-SARSAT earlier this year and has been submitted to Transport Canada for regulatory approval. This research program will put lifesaving technology within the reach of most aircraft owners.

For more information on this project, contact Howard Posluns at 514 283-0034 or poslunh@tc.gc.ca. △

Floatplane Fuelling

by Robert Laporte, Civil Aviation Safety Inspector, System Safety, Ontario Region

Though this article is meant to inform floatplane-fuelling operations of the safe and recommended practices, the information presented is applicable to all overwing fuelling operations. The term overwing fuelling is applied to fuelling operations using conventional hand-held and controlled fuel nozzles.

Aviation fuels generate an electrostatic charge when passing through filters, pumps, piping, and hoses. This charge, if not dissipated, is a potential ignition source for fuel vapours and therefore a serious fire hazard. The accepted method for neutralizing this charge is by bonding the aircraft to the fuelling system.

Bonding is the process of connecting two or more conductive objects with a conductor. Normally, a braided conductive cable with a clamp, jack, plug or clip is attached to the aircraft at one end, and to the fuel system at the other end to accomplish this bonding.

Many float operators wrongly believe that floatplanes in water are grounded and do not require bonding. National Fire Prevention Association (NFPA) studies have determined that grounding (the process of connecting conductive objects to the ground) is no longer required because it does not prevent sparking at the fuel surface. Bonding is the recommended method of controlling static electricity during fuelling. (Reference NFPA 407)

All aircraft, including floatplanes and the fuelling equipment through which fuel passes, require bonding. Companies with an air operator certificate (AOC) are mandated by their company operations manual (OM) to bond their aircraft during fuelling. The bonding cable should be connected to designated airframe points or to clean, unpainted surfaces of the aircraft prior to opening the fuel cap. This ensures that the fuelling equipment and the aircraft are at the same electrical potential and thereby dissipate and neutralize any charges present and any charges generated during the fuelling process.

Aircraft should be bonded as per the following sequence:

- 1) Attach the bonding cable to the aircraft.
- 2) Attach the fuel nozzle bonding cable to the aircraft prior to removing the fuel cap. If the nozzle does not have a bonding cable, touch the fuel cap with the nozzle prior to removing the fuel cap. During fuelling, the nozzle should be in continuous contact with the filler neck to neutralize the build-up of electrostatic charges.
- 3) Remove the nozzle when fuel transfer is complete.
- 4) Replace the fuel cap.

- 5) Disconnect the fuel nozzle bonding cable if applicable.

- 6) Stow the fuel hose.

- 7) Disconnect and stow the bonding cable.

Conductive fuel hoses are also required to neutralize any charges built up by the flow of fuel inside the hose. The conductive fuel hose is in addition to the bonding cable and is not meant to replace the bonding cable or to achieve the required bonding.

Fuelling precautions

Those involved in aircraft fuelling require training and shall wear clothing of natural fabrics or fabrics that do not generate static electricity. Companies handling aviation fuels are also required to have an emergency response plan to deal with fuel spills and fires.

Fuelling is prohibited if thunderstorms are in the immediate vicinity. Fuelling operations shall be suspended and bonding cables removed if lightning is observed within 8 km of the aerodrome.

If aircraft battery power is required during fuelling, the aircraft's external lighting, strobe lights and rotating beacon should be turned off.

Air operators may have procedures for fuelling with passengers on board. Because of its lower flash point and higher volatility, passengers should always be disembarked when fuelling avgas.

When conducting fuelling operations, a 3-m safety zone should be established around the filling and venting points. Only essential personnel should be allowed in the safety zone. Fire extinguishers should be strategically located and clearly marked. Vehicles not involved with fuelling should be prohibited within 15 m of the aircraft.

The following are prohibited inside the 3-m fuelling safety zone:

- Smoking
- Open flames
- Passengers
- Use of radios
- Electronic devices such as cell phones, pagers, CD players, etc.
- The operation of electrical switches
- Use of photographic flash equipment (bulbs or electronic)
- Motorized vehicles
- Any activities that could produce a spark

For more information on fuelling, consult the Canadian Standards Association (CSA) B836-00, at The Canadian Standard for Storage, Handling, and Dispensing of Aviation Fuels at Aerodromes, at www.csa.ca. △

Recreational Aviation

Serge Beauchamp, Section Editor (E-mail: beauchs@tc.gc.ca)

Ballistic Recovery System Parachutes: The Lifesaver

In our two previous issues of *Recreational Aviation*, Inspector Martin Buissonneau carefully guided you through the process of safely purchasing an ultralight aircraft. In this issue, we hope to convey the idea that when looking to buy a small ultralight aircraft, it may be worthwhile to also look into the purchase of a lifesaving device called a ballistically deployed emergency parachute, often called a ballistic recovery system (BRS). After all, when we buy insurance, we don't do it in the hope of having to use it, but more in the eventuality that if ever we need it, it's there to help out. I believe that the adoption of such a device should be viewed on its merits like an insurance policy. This is not a sales pitch; this is safety.

History

In the U.S., the ballistically deployed emergency parachute came about following a flying accident that nearly cost the life of its designer. Mr. Popov of Saint Paul, Minnesota, held a pilot licence and flew conventional aircraft and hang gliders. One day, as he was towed over a lake by a powerboat with an overzealous tow driver to a height of 400 ft, the hang glider collapsed and he plummeted to earth. He thought for sure that he was going to die and became most annoyed at the fact that there was nothing that he could do to save himself.

Thankfully, as a trained gymnast he conditioned himself for a crash landing in the water and he survived with a bruised kidney and some broken teeth. He knew that parachutes existed but had not yet been introduced to the hang gliding community, so he set out to design one that could be deployed in flight and at low altitude, to save someone from impending doom. His design team went on to develop a system that is approved by the Federal Aviation Administration (FAA), and is widely used around the world by the ultralight aircraft community, as well as on certificated aircraft, such as the Cirrus aircraft, and as a supplemental type certificate (STC) modification to the Cessna 150/152 series and the Cessna 172.

Design

American and European manufacturers offer various sizes of emergency parachutes for different types of aircraft. There are recovery systems for certificated aircraft, trikes, hang gliders, ultralights and advanced ultralight aircraft and companies may help you adapt one on your amateur-built aircraft.



How it works

The very small and lightweight parachute is located in a special canister close to the aircraft or ultralight aircraft's center of gravity. It is propelled out of the canister by a solid fuel rocket motor and deploys at various speeds, depending on the height of the aircraft, to preclude any structural failure of the canopy. The pilot manually deploys the system by pulling a handle. Flying small aircraft is no ordinary undertaking and has to be taken seriously as it is most unforgiving of mistakes. In the eventuality of a structural failure or if a downdraft, wind shear or any atmospheric conditions prevent you from maintaining control of your aircraft at low or high altitude and a crash is imminent, isn't it great to know that you can count on such an emergency system to save you from severe injuries and allow you to continue to enjoy life again?

Life is very precious, especially when a death or an injury could have been yours or that of a member of your family. The liability of taking action and

adopting such a lifesaving device to your aircraft is far lower than that which is left behind for your family to manage after a crash. Safety should be at the forefront of any of your planning action when you practice the wonderful sport of flying. For the record, in the U.S., several thousand emergency parachutes have been installed since the early 1980s and over 150 lives have been saved by this lifesaver. Take a look at Web sites of American and European manufacturers and see how they can

help you achieve the highest level of safety for your flying experience: www.brsparachutes.com, www.Junkers-profly.de, www.galaxysky.cz/grs/eng/index.php?k=index, and www.air-contact.de/rettung.htm.

Look into a ballistically deployed emergency parachute for your ultralight aircraft; it's a question of safety. Any death or serious injury that can be avoided through any reasonable means justifies the means. —Ed. 

A Stall at Pattern Altitude Claims Another Life

The pilot of a Lazair ultralight aircraft had taken off to practice touch and go. He was proceeding on a wide left-hand circuit downwind for landing. He had been sequenced number one and as he turned base, witnesses heard both engines stop. The aircraft continued on what looked like a power-off glide back to the airport. The Lazair ultralight aircraft is equipped with two small 185 cc Rotax engines mounted forward of the leading edge of the wing, and the pilot sits underneath the wing. As the aircraft approached final, the wings were seen to rock from side to side. The aircraft then nosed over to about a 90° angle and the pilot was unable to recover from the dive, even though the altitude from which it was begun was reported to be close to 500 ft. The pilot lost his life. Each year stalls account for a high number of mishaps and many deaths. They often occur in the pattern, after takeoff or when coming in for landing. Flying low and tight circles over a friend's house has also claimed the lives of many pilots. Stalls are often related to a sudden engine failure, poor take-off or landing techniques, and the failure to recognize the onset of a stall. A review of the theory of flight and the stalling characteristics of your airplane with an experienced instructor should help you stay out of trouble, especially if you train regularly. No one is immune to the danger of a stall, as it claims lives indiscriminately.

Stalls can be prevented. The warning sign is usually an unmistakable buffet or shaking of the airplane. The buffeting is the result of the airflow separating from the top of the wing. It can occur very quickly depending on the angle of attack, angle of bank and the gross weight of the aircraft. It needs your immediate attention. To recover from the stall, reduce the angle of attack by gently lowering the nose of the airplane with the elevator control. Once the angle of attack is less than its critical angle, the air molecules will flow smoothly over the top of the wing again and the production of lift will resume. It's as easy as that. Remember that you must apply all available power to accelerate the airplane and help reduce the angle of attack. You then have to return the aircraft to the desired attitude and watch that you don't stall again. When you exceed the critical angle of attack, the aircraft wings lose all lift and if your altitude is too low for a recovery, you will fall uncontrollably to the ground. The critical angle of

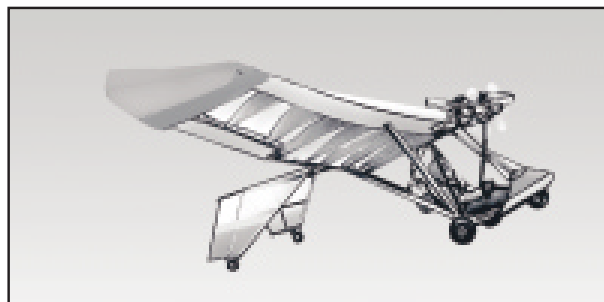

attack is usually close to 18°. When you are flying at or close to this angle, the air molecules racing over the top of the wing cannot provide a uniform, high-velocity, laminated airflow, and the wing stalls.

Remember that at the moment the wing stops flying, it creates stress in your mind and you may have a tendency to do the opposite of that which is required to regain lift. As the airplane pitches nose down, many will have the instinct to pull back on the elevator control. Don't. Release back pressure on the controls and apply power. You must realize that airplanes can be stalled at any altitude or at any airspeed. It will occur when an airplane exceeds its critical angle of attack, independent of attitude and airspeed.

In most cases, there are five warning signs.

- 1- The unmistakable buffet or shaking that is usually felt in the airplane and on the flight controls.
- 2- Flight control response diminishes when the airplane approaches the stall. Controls may feel mushy and less effective.
- 3- The airspeed indicator approaches the beginning of the white or green arc.
- 4- A distinctive difference in sound occurs as wind noise diminishes considerably.
- 5- A stall warning horn will be heard (if the aircraft is equipped with one).

There is a sixth sign that will be felt depending on your perception of subtle differences in your weight against the seat cushion; this is a certain weightlessness as you gravitate upward while the aircraft wants to proceed downward.

As a pilot, you owe it to yourself to practice stalls and to be able to recognize the conditions that lead to them. This is a very brief review and I leave you with this thought—the airplane will always stall when the wings exceed their critical angle of attack. Keep those wings flying. 

Spring Inspection of Your Aircraft—A Must

When you fly an ultralight, amateur-built or normal category aircraft that you have registered with owner-maintenance classification, you are faced with the responsibility of carrying out the maintenance of your aircraft at least once a year. This is a considerable task, as you first have to create a process that will ensure that your aircraft will remain airworthy during the period that you've determined to be the minimum interval between inspections. It is a major responsibility, as you must guard against any civil lawsuits that may be brought against you or your heirs following a crash or mishap.

When you carry out your own maintenance, you become the authority that attests to the airworthiness of the aircraft and therefore you are solely responsible for any outcome that may question your ability to perform such maintenance work. It is a considerable task because, unlike full-time aircraft maintenance engineers (AME) who stay current by performing daily inspections and repairs, you do it only sporadically. It is crucial that you have a plan of action. Like full-time AMEs, you must use checklists to ensure that your inspection covers the whole aircraft including the engine, propeller and flight controls. Even if it is a simple aircraft, a checklist will assist in ensuring that all is covered. It may be used as evidence that you have carried out the work in case of litigation. You must also create an additional checklist consisting of items that have been known to fail or weaken over time and that the manufacturer or type club have found important to add to a maintenance checklist. The checklist can also be used to compare notes with others who operate the same type of aircraft and ensure that nothing is forgotten or left to chance.

Do you have the aircraft and engine manufacturer's inspection checklist? If not, look up your aircraft type club or the aircraft, engine and propeller manufacturers on the Internet. You can also find assistance through discussion groups on similar Web sites—they can be a Godsend.

Each year, usually in the spring or early summer, pilots of ultra-light and general aviation aircraft experience various engine failures, flight control failures and sometimes even structural failures that lead to injuries and death. Most of the time the mishaps can be traced back to poor maintenance practices. Aircraft and engine components are subject to fatigue, wear and tear. That is the reason for inspections. Aircraft have to be maintained diligently in a manner that will prevent any major problems from occurring. Aircraft and engine manufacturers' recommendations are the minimum amount of maintenance required to ensure your safety; however, the more you do to ensure that your aircraft is airworthy, the better. Your first order of the day is to get out all of the maintenance manuals, checklists, and proper tools, as well as spare parts that will serve as replacements. Second, is to review inspection procedures for structural, engine and propeller components. What will you be looking for? How will you be able to assess wear and tear, and repair accordingly? Who can assist you if you are unsure of being able to do the work correctly? Lives will depend on your assessment of the airworthiness of the various aircraft parts. Can you do it? Do not hesitate to ask a professional for help. 

Exhaust System Failures: A Severe Flight Hazard

All aircraft systems deserve respect—especially the exhaust systems. They are crucial to your engine's performance as they help it breathe in the air-fuel mixture that will give you the rated power. In addition, the exhaust system supplies you with carburetor and cabin heat necessary for your comfort, as well as preventing carburetor ice build-up. Many two-stroke light aircraft engines depend on the specifically-designed, tuned exhaust system in order to ensure that it will give the rated power. As soon as any modification to the system occurs, the pilot will notice that the engine is not performing adequately. On four-stroke engines, a small exhaust crack will most likely fail to show a decrease in power. Think of the exhaust system as a channel, much like a river, through which air flows like water. Exhaust gases flow and create a partial

vacuum behind them that assists the engine on the following intake stroke to admit the new air mixture, allowing you the best fuel-air mixture for best combustion and power.

What often gets the least attention during inspection? What is the last engine accessory light-aircraft owners who do their own maintenance review during the aircraft inspection? You guessed it, the exhaust system. They are often taken for granted. Here are two tragedies that could have been prevented.

A young instructor and a pilot friend had set out to practice touch and go on an early July evening. Both were in their mid-twenties and had a wonderful future ahead of them. They had performed two landings and had taken off again to perform another circuit when the flight service station (FSS)

specialist called them on the radio to tell them that they were trailing smoke. At the same time they acknowledged the radio transmission, smoke started pouring into the Taylorcraft BC-12D cabin. They proceeded immediately to return for landing, but the cabin was quickly engulfed in flames. Control of the aircraft was lost, and soon after it fell to the ground. The investigation revealed that both pilots had suffocated and likely had died before reaching the ground. The cause was a failure of the exhaust system. The aircraft had been put through its annual inspection just a few hours before the crash but the engineer had failed to see the well-hidden crack that started at the exhaust pipe flange. Had the exhaust system been removed from the engine for inspection, it is very likely that the crack would have been seen and the soot marks around its opening would have been noticed.

In another case, two friends set out for their annual trout fishing trip in early summer. The aircraft was the revered Piper Super Cub and had received its annual inspection just days before. It was late Friday afternoon when they loaded all of their gear aboard the plane, filed the required flight notification (FLNOT) with the pilot's wife and took off for camping at their favorite fishing spot. Monday, when they failed to return, search and rescue (SAR) was notified and found the aircraft along its intended track in the woods. The aircraft seemed to simply have flown into the trees, as it had left a trail of broken branches on the forest rooftops before impact. The investigation revealed that both passengers had lost consciousness in flight and the aircraft continued until it gradually lost altitude and made contact with the top of the trees which slowed it down and it crashed. Unknowingly, both passengers had become intoxicated from carbon monoxide fumes expelled by a broken exhaust pipe. It had entered silently and surreptitiously contaminated the cabin. In both cases, the engineers who performed the annual inspections were very familiar with these specific aircraft and it is possible that some complacency may have allowed for the events to occur.

Aircraft and engine manufacturers, as well as Transport Canada and other civil aviation authorities, insist that the exhaust system receive a very thorough inspection at least once a year. There

are airworthiness directives (AD) such as CF-90-03R2 that give specific instructions on how to proceed in the inspection. This information is available on the Transport Canada Web site at www.tc.gc.ca/CivilAviation/certification/continuing/ad.htm. The Federal Aviation Administration (FAA) has numerous documents available online for inspecting exhaust systems. Take a look at www.faa.gov/fsdo/orl/files/advcir/AC91-59.TXT.

Exhaust system parts fail because of metal fatigue, corrosive environments, continuous stress at flange mating areas, vibrations, repeated cycles of heating and cooling, looseness of components and other factors such as material thickness, material compatibility fabrication methods, etc. Tests performed on aircraft have shown that cracks may appear after between 100 and 200 hours of operation. One half of the failures noted were on the heat exchanger surfaces used for carburetor and cabin heat. Apart from cabin contamination, failure of the heat exchanger surfaces may allow for gases to be drawn into the induction system, causing overheating and power loss. Erosion and carbonizing of the surfaces are the primary causes of internal failure. Any lead pencil mark left on exhaust pipes or any exhaust system part is likely to lead to a premature crack, as the lead causes a heat concentration that degrades the base metal and weakens it through carbonizing. The efficiency of the engine and exhaust system depends on you; always give it your best.

Carbon monoxide detectors are available for any airplane. They can be of a type that is passive, such as a type that has a chemical patch that reacts to any cabin environment contamination of carbon monoxide. This type has a limited life and should be replaced annually. There are active carbon monoxide detectors that use a chemical detector with associated integrated electronic circuitry, a light and an audible warning system to alert the pilot and passengers of contamination. This system either works with the help of a 9-V battery or is pre-wired into the aircraft electrical system through the help of a supplemental type certificate (STC). Any carbon monoxide detector can help reduce the risk of cabin contamination by this deadly odorless gas. Look into the matter before setting out on your next flight. 

Taken from the TSB and CADORS File

Tide and current play havoc with the landing of an amphibious aircraft: The pilot of a SEAREY aircraft was carrying out a demonstration flight on the Fraser River. Upon landing, the nose of the aircraft hit a swell and went under water. The cockpit filled rapidly and the aircraft began to sink. The pilot was able to unbuckle his seat belt, surface, and inflate his life vest, but his passenger was not so lucky. He sustained a fatal injury to the head during the sudden deceleration and drowned. There are limits of operations beyond which safety cannot be assured. A river close to the ocean, such as the Fraser, experiences the effects of the tide and current daily. These represent challenges that can easily catch the unwary pilot and lead a flight to disaster. The solution is to train and limit operations within well-defined parameters of flight. 

COPA Corner—Who Is Responsible for Aircraft Maintenance?



by Adam Hunt, Canadian Owners and Pilots Association (COPA)

The COPA office gets many interesting questions each month from pilots, aircraft owners and people who work on aircraft. One of the most topical questions I received recently, from a safety perspective, was that of “who is responsible for aircraft maintenance? Is the aircraft owner responsible or is it the person who does the maintenance?” On certified aircraft the person doing the maintenance could be an aircraft maintenance engineer (AME) or apprentice, or it could be someone else if “elementary work” is the action being carried out.

This question is important from a safety perspective because if it is not clearly understood who is responsible for what, then maintenance may get missed. Some AMEs will tell you that under the *Canadian Aviation Regulations* (CARs), the owner is responsible for all maintenance on the aircraft, not the AME. Aircraft owners will point out that they cannot be responsible for the torque on each bolt or the workmanship of lockwiring, because they lack the expertise in those technical areas. If they had to know all that, then only AMEs could own aircraft! Both arguments are partly right, but the answer is in the CARs, of course!

Maintenance Schedule

605.86 (1) ...no person shall conduct a take-off in an aircraft, or permit a take-off to be conducted in an aircraft that is in the person’s legal custody and control, unless the aircraft is maintained in accordance with

(a) a maintenance schedule that conforms to the *Aircraft Equipment and Maintenance Standards*...

This CAR clearly indicates that the aircraft owner is responsible to make sure that the aircraft is maintained to a maintenance schedule. If the aircraft wasn’t sent for an annual inspection, the owner is responsible.

So what are the people who do the actual work responsible for?

Maintenance and Elementary Work Performance Rules

571.02 (1) ... a person who performs maintenance or elementary work on an aeronautical product shall use the most recent methods, techniques, practices, parts, materials, tools, equipment and test apparatuses that are

(a) specified for the aeronautical product in the

most recent maintenance manual or instructions for continued airworthiness developed by the manufacturer of that aeronautical product;

(b) equivalent to those specified by the manufacturer of that aeronautical product in the most recent maintenance manual or instructions for continued airworthiness; or

(c) in accordance with recognized industry practices at the time the maintenance or elementary work is performed.

CAR 571.02 makes it pretty clear that the person carrying out the actual maintenance or elementary work is responsible to do the work that the owner asks them to do, correctly and as specified in the appropriate publications cited.

A further indication that the person carrying out the work is responsible for the work that they actually do is contained in this CAR:

Maintenance Release

571.10 (1) No person shall sign a maintenance release required pursuant to Section 605.85 or permit anyone whom the person supervises to sign a maintenance release, unless the standards of airworthiness applicable to the maintenance performed and stated in Chapter 571 of the *Airworthiness Manual* have been complied with and the maintenance release meets the applicable requirements specified in section 571.10 of the *Airworthiness Manual*.

(2) ... a maintenance release shall include the following, or a similarly worded, statement:

“The described maintenance has been performed in accordance with the applicable airworthiness requirements.”

So, who is responsible for the maintenance carried out on an aircraft? The CARs are clear that the aircraft owner is responsible to make sure that the maintenance required is scheduled and the aircraft is made available to the person who will do the maintenance or elementary work. The person who actually does the work is responsible for the actual work that they have been asked to do and that they carry out. Both have responsibilities!

Aircraft owners and maintainers need to work together to make sure that aircraft are properly maintained, airworthy and safe to fly! △

Vancouver/Victoria Airspace: Are You in Conflict?

A risk management study was conducted by Transport Canada, Pacific Region, regarding high-density air traffic airspace in the Vancouver/Victoria terminal areas. Pilots are urged to follow the published procedures, instructions and notes as depicted on the Vancouver VFR terminal area chart (VTA), and to use the proper radio frequencies in the airspace they transit. VFR pilots, in particular, should be cautious at VFR checkpoints and traffic convergence area (i.e. PT GREY, PT ATKINSON, BOWEN IS or ACTIVE PASS). Training flights should be conducted in designated areas [i.e. advisory area (CYA) (T)], and avoid airways and air routes. All pilots operating in Class E airspace must be vigilant of uncontrolled traffic. And of course, pilots are strongly encouraged to review collision avoidance procedures (i.e. “see and be seen, see and avoid”) and to maintain a high level of situational awareness in this busy corridor. We want you around for the Olympics! △

I Have Seen The Eyes of Death—Part I

Adapted from the original article “I Have Seen The Eyes of Death,” by Dr. John Albrecht, family physician, aviation medical examiner and active pilot

December 6, 2000, Tofino Airport, B.C., weather was brilliant sunshine with a cloudless sky and a light westerly sea breeze—the scene was set. In the unseasonably warm conditions, an American businessman was preparing his Cessna 182 for his return flight to Oregon. He was completing his solo cross-country trip as a student pilot. The serenity of the morning was broken by the faint forlorn moan of the Leonard Island foghorn. With disbelief and apprehension for the rookie pilot, a quick telephone call confirmed that indeed a fogbank was moving in from the Pacific. A glance to the west revealed a thin white line on the horizon. His pre-flight seemed to take forever. At last he strapped in and fired up. With increasing alarm the onlookers realized that he was taxiing for Runway 28—a westbound departure into a light wind. Another observation noted that the grey wall had reached the golf course at the western boundary of the airport and was advancing in leaps and bounds! Sensing trouble, one of the pilots jumped into a silent Beaver, hit the master switch and transmitted a brief warning... “Dave, don’t take off that way!” By this time, he was positioned on the threshold of 28 for takeoff and transmitted back, “I check that.”

The aircraft began to accelerate. Initial relief turned to horror as the huddled group realized that he was not returning to the apron but taking off. The 182 climbed only to 250 ft AGL when it entered the fog bank at mid-field, and the right wing had already dropped as it was engulfed. Out of sight, the engine sounds gave testimony to the remainder of the flight. For several seconds they were normal and then rapidly increased into a shrill crescendo, a brief flutter, followed by the final impact. Then silence. The flight had been just under one minute in duration. One of the veteran pilots dejectedly confirmed what the rest feared... “he just killed himself.” A brief search in the mist located the burnt wreckage just a quarter mile north of the departure runway. The pilot’s family had difficulty comprehending how a beautiful day could turn into tragedy.

As a family physician, aviation medical examiner and active pilot with 28 years of flying experience, I have some understanding of the factors involved in this preventable accident. A review of my log books brings to vivid recall my four encounters with the terrifying condition that resulted in this crash:

1. February 26, 1975—Student pilot. Entered snow squall with instrument conditions east of Pitt Meadows Airport, B.C. Solo, 30 hr total time, instrument time—nil. Inexperience with deterioration from VFR to IFR conditions.

2. August 21, 1977—Private pilot. Encountered instrument conditions in heavy rain east of Denman Island, B.C., on flight from Comox, B.C., to Pitt Meadows, B.C. 320 hr total time, instrument time—13 hr (Hood). Wife and two daughters. “Get-home-itis” with rental aircraft. Marginal VFR.
3. July 17, 1978—Private pilot. Inadvertently entered cloud over Bowen Island, B.C., in VFR conditions on flight from Pitt Meadows to Comox. 390 hr total time, instrument time—24 hr (Hood). Wife and two daughters. Visual illusion of cloud proximity. Wife did not fly with me for the next 20 years!
4. August 6, 1982—Private pilot. Flew into a fogbank departing Ocean Shores, WA, for Newport, OR. 790 hr total time, instrument—32 hr (Hood). Flying partner with one child each. “Get-home-itis.”

In three of these situations, VFR conditions were forecast when instrument meteorological conditions (IMC) were encountered, after which aircraft control was in doubt, if it existed at all. There is only one reason that I am on this side of the twilight zone to take pen to paper—blind unmitigated luck. I hope that other pilots can learn from my past errors.

Each of the above scenarios has a common flight phenomenon—SPATIAL DISORIENTATION. Disorient means to mix up; confuse; to cause to lose one’s sense of direction, perspective or time. Spatial disorientation is the loss of position sense in relation to the earth’s surface. In the aviation environment, the ultimate consequence is loss of control with the terminal manoeuvre being a spiral dive—often vertical or inverted!

While the disorientation accident is preventable, no pilot is immune to the deadly phenomenon. It is difficult for the uninitiated aviator to comprehend



The Eyes of Death may come in a group of six...

the danger of pressing on from visual to instrument conditions.

The Transport Canada “*Take Five....for Safety*” entitled “*178 Seconds*,” describes the typical scenario of scud running. It refers to a research project set up to determine how long non-instrument rated pilots take to lose control of their aircraft in simulated instrument conditions. The range was 20 to 480 seconds with an average of 178 seconds! Once in instrument conditions, their average lifespan was just under three minutes—of the 20 students all eventually lost control.

Several years ago on an instructor re-ride, Roy Israel gave me an in-flight demonstration that is nauseatingly vivid to this day. He mimicked the flight control inputs and gyrations of a recent commercial pilot candidate flying straight and level under the hood. The initial transgression was a gentle right spiral dive, then a brief correction to straight and level. Next the nose came up and we rolled left and into a spiral dive that was near vertical with alarming speed. It was all we could do to throttle back and recover before the engine redlined. My mouth was dry and heart raced as my mind drifted back to 1978 and Bowen Island...

The weather for this flight from Pitt Meadows to Comox was VFR, as forecast, with residual cumulus over Howe Sound and the North Shore mountains. The trip was uneventful as we droned westward toward Bowen Island. A cloud bank over the mainland did not appear to be a problem. POOF! Instant grey, uniform and everywhere. No horizon, mouth dry, fast pulse. Wife: stone silent! Oldest daughter in the rear seat, a seasoned aviator...“Daddy, it’s foggy outside.” A quick look left then right, still no horizon. A swivel over both shoulders and still no outside reference. The engine droned on but my brain says we’re suspended in time and space. A voice inside my head shrills, “Jack, you are in deep trouble!” Check the flight instruments. Impossible! We entered this mess straight and level and my mind and body feel the same but...the airspeed indicator is unwinding through 50 kt and the attitude indicator shows the little aircraft profile in a nose up and right bank attitude. Unusual attitude with a stall seconds away! Recover, nose down and level the wings. Turn to reciprocal heading and wait and

wait and....time stands still, loses all meaning. Then POOF! English Bay, anchored freighters and a natural horizon! The rest of the flight was uneventful.

This brief insightful encounter with disorientation made me an instant believer of its deadly peril. I was astounded by the rapid transition from controlled flight to an unusual attitude in mere seconds. Contributing factors included surprise, distraction and the surreal world of instrument conditions. Under these conditions, 24 hr of hood time was almost not enough to survive. There is no doubt that in-cloud (“actual” IFR) experience is invaluable. The importance of recognizing and recovering from unusual attitudes was driven home, as was the pre take-off setting of the heading indicator for the reciprocal turn. In retrospect, I did commit two errors: the turn, rather than rate one (3° per second), was a steep aerobatic fighter pilot variety and to the right towards the concealed peak of Bowen Island. I will never know how close we came to terrain and I don’t care to. There was a touch of panic and the adrenalin was flowing hot. But we survived to fly another day.

It is difficult to describe the emotional and physical reactions in this situation. In aviation, a close encounter with another aircraft always results in a strange metallic taste in my mouth—the taste of raw adrenalin. However, the absolute dysphoria and terror of spatial disorientation is by far the worst and for many pilots the last they will experience. One of my sage flying instructors, John Brongers, put this into perspective after I recounted to him my Bowen Island fiasco. “Jack,” he asked, “if I was sitting in the right hand seat, instrument rated, and told you I could fly you out of this mess, would you sign this blank cheque?” I responded “Yes, immediately!” The amount was immaterial and the recipient could have been the devil himself. I call this “Lotto Equivalent” dysphoria. It is hard to convey to the non-aviator the intensity of the mental anguish.

In Part II of this article, Dr. Albrecht will address the specifics of spatial disorientation. In the meantime, the lessons described here should suffice to make us think twice before flying into deteriorating weather. —Ed. △

Transponder Operation in a Non-radar Environment

In a radar environment, transponders are very useful in providing your position, speed, and altitude to air traffic controllers. The transponder has another important purpose in the operation of the traffic alert and collision avoidance system (TCAS). A TCAS-equipped aircraft has the capability of interrogating your aircraft transponder and by doing so determines if a conflict exists. Once TCAS has determined that action should be taken to avoid a collision, it will give the pilot of the TCAS-equipped aircraft directions to follow to avoid a collision. In addition, some aircraft are getting fitted with on-board traffic advisory systems, which are cheaper than TCAS, but which monitor intruding aircraft transponders within a few miles. Therefore, do yourself a favour and ensure that your transponder is turned on at all times, in radar and non-radar environments. You may not have TCAS or an on-board traffic advisory system in your aircraft, but others who do will be able to avoid you in case of conflict. △

Collision with Mountain

On September 28, 2002, a de Havilland DHC-3 Otter took off from Lac de l'Avion, Quebec, near Natashquan Airport, at approximately 10:50 eastern daylight time (EDT) on a flight to a hunting camp 57 mi. to the north, along the Aguanish River. The pilot and three passengers were on board. Upon arriving at the destination at approximately 11:35, the aircraft flew over part of the neighbouring forest before crashing upside down on rugged ground. The pilot survived but the passengers were fatally injured on impact. This synopsis is based on the Transportation Safety Board of Canada (TSB) Final Report A02Q0130.

The pilot had logged about 7 980 hr of flying time, with almost 7 800 hr on aircraft equipped with floats or skis. As the company chief pilot, he was responsible for professional standards for the flight crew under his authority. Weather conditions during the first 40 nautical miles (NM) allowed for a direct course. However, for the rest of the distance, clouds frequently came down to the mountain tops, forcing the pilot to make a few detours. The weather conditions at Natashquan Airport improved from 10:18 to 11:43, and the cloud base rose from 600 ft to 5 500 ft above ground level (AGL); however, in mountainous terrain, it was possible for clouds to remain longer.

The mountain bordering the north side of the Aguanish River at the hunting camp is very steep. The pilot had not been to the location for a year and flew over the camp to assess the landing area. He also noticed moose tracks on the bank and initiated a turn to the left to show the passengers. The turn was done at approximately 95 mph. It seemed to the pilot that, during the turn, close to the mountain, the aircraft drifted toward the mountain. After almost completing a 360° turn, the pilot felt vibrations that he associated with wake turbulence. Because the aircraft seemed to want to sink, he applied full power. The left wing hit the tops of several trees, and the aircraft flipped before crashing upside down on the slope of the mountain.

The aircraft cut a 460-ft-long swath through the trees along a constant left curve. At first, only the treetops were involved, but the aircraft quickly dropped, cutting the trees progressively closer to the ground. The aircraft's speed fell and the left wing tore off. The take-off weight was within prescribed limits, and the aircraft was equipped and maintained in accordance with existing regulations. The TSB determined that the engine was producing high power. The continuity of the control cables could still be established—despite the separation of the left wing—because the cables did not break.



The pilot had not noticed anything unusual about the aircraft's operation before the accident.

The manufacturer was contacted to determine the consequences of wake turbulence on a flight trajectory if an aircraft of this type crossed its own wake turbulence after making a 360° turn. According to the experts, even in still air, it is hard to cross one's own wake turbulence. Furthermore, even if this had occurred, the bumpiness felt would have been minimal and immaterial.

The onboard GPS had the capacity to save the last five flights in memory. Analysis of this data showed that for the first 32 NM, the aircraft followed a constant course. However, the aircraft followed the Aguanish River to its destination for the last 25 NM. A more detailed analysis of the last three points recorded by the GPS indicated that the aircraft's bank was between 18° and 35° for most of the 360° turn.

Analysis—As the pilot progressed to the final destination, the ceiling dropped. He chose to follow the course of the Aguanish River to reach the destination because clouds were touching the tops of the mountains. At the destination, he made a 360° turn. Because the mountain was sloped at 40° and clouds obscured the top, it seems that the pilot had trouble judging the horizontal and vertical distance between himself and the mountain. He noticed only at the last moment that he had drifted much too close to the mountain.

As he was approaching the mountainside, the pilot felt vibrations, probably from the first impact with the treetops. Although he increased engine power, he could not get out of the predicament because of the low ceiling, the proximity of the mountain, and a bank angle that he could not increase. Because of the geographic and weather conditions, the pilot probably had trouble judging his horizontal and vertical distance with respect to the mountain, and the aircraft crashed. △

The National Search and Rescue Secretariat and the Search and Rescue Association of Alberta invite you to **SARSCENE 2004**, which will take place **October 13–16, 2004 in Calgary, Alberta**.

Don't miss the games, workshops, tradeshow and search and rescue demonstrations.

For more information, visit www.nss.gc.ca or call 1 800 727-9414.



Class D Airspace at Bagotville, Quebec

Dear Editor,

Just over two years ago, Bagotville air traffic control (ATC) established a Class D controlled airspace for all VFR aircraft flying above 1 200 ft AGL within 30 mi. of the Bagotville Airport. Several incidents have occurred lately, mainly due to the lack of awareness of this airspace. Several pilots have simply not communicated with ATC, and created dangerous situations for other pilots. Unfortunately, this controlled airspace does not yet appear on the VNC map for the region of Chicoutimi. However, it is indicated in the *Canada Flight Supplement (CFS)*. I encourage all pilots in the region, and those who are passing through, to familiarize themselves with this zone in order to ensure the safety of all.

*Capt F. Chouinard
Air Traffic Control, Bagotville, Quebec*

The Flight Safety Officer (FSO) at Canadian Forces Base Comox also contacted me with reference to some incursions into active military airspace by civilian aircraft in recent months. Here are some examples of conflicts they encountered. While operating VFR-over-the-top in CYR107, a military aircraft came within 1/2 mi. of a civilian DHC-2 Beaver at the same altitude, necessitating an evasive action. The Beaver left the area, and the military aircraft continued its mission. In another case, during a

crew training flight in CYR106, a civilian aircraft was observed to operate at 9 900 ft without authorization. This was also a DHC-2 Beaver, owned by local commercial operator. The military crew contacted the civilian aircraft and arranged mutual separation. The civilian pilot reported that he was conducting a bird survey and had filed a company flight note but not a flight plan. The pilot was aware of the air defense identification zone (ADIZ) requirements but appeared unaware of the CYR106 procedures. The FSO wants to stress the dangers of unauthorized incursions into active military airspace and military control zones. He points out that GPH 204, the military flight planning and procedures document lists 10 restricted areas for British Columbia, as well as four military advisory areas. This information is documented as well on various flight charts but it is not (surprisingly) contained in the CFS. He stressed not only the need to educate pilots who stray into military airspace, but also their supervisors, instructors and dispatchers. Since military aircraft are often involved in high-speed manoeuvres, dropping or firing objects, this is not where a civilian pilot wants to wander around. An in-depth pre-flight of the route to be flown is the key to avoiding military areas. —Ed. △

The ASL Interview—Corey Nordal *(continued from page 16)*

ASL: *Do you have an aviation safety inspection program?*

C.N.: Yes, we brought that in with the implementation of the SMS, and we did the audits and reported them online. This year we're trying to streamline the forms and have the people do the audits for the place where they are actually working. This gets more people involved and gives them an idea of the regulations and what should be around their workplace. The reports from the groups all go on the Web site and I review them and pass on any deficiencies to the appropriate managers, who in turn fix the problems. Once the corrections are done, the managers advise me, and I forward the complete report, with dates and so on, to the operations manager.

ASL: *What benefits have you seen from having a safety program since 1991?*

C.N.: I think the biggest benefit has been employee participation, everyone in the organization knows that it's there, and they do use it. In turn, we act on the reports they submit.

ASL: *What would you say was your greatest challenge in being a safety officer?*

C.N.: Trying to stay active, to keep an active program in place, trying to avoid apathy. If we're

doing fine and not having major problems, it's hard to keep a good mental attitude about promoting safety.

ASL: *Do you encounter any resistance from the employees, for example do they feel you are getting them to do things that don't need to be done?*

C.N.: No, I don't think they feel that way, at least they haven't told me. We try to make the reporting system as simple as possible. With the Web site, they report it once and then they are done with it. Then it's up to us to act on it and eventually give feedback to the employees.

ASL: *What do you see in the future for your safety program?*

C.N.: We'd like to see the use of our system expanded, not only more use by our employees but we'd like to see other branches in Saskatchewan Environment make use of our program or develop similar SMS programs for aviation activities of their own. If the whole department could operate as safely as possible we'd be doing a good job.

ASL: *Is there anything you would like to add that I didn't ask you about?*

C.N.: If anyone wants to find out more about our system they can contact me anytime by phone at 306 425-4585 or by e-mail at CNordal@serm.gov.sk.ca. △

The ASL Interview—Corey Nordal, Aviation Safety Officer with Northern Air Operations (NAO)

by Thomas T. Umscheid, Civil Aviation Safety Inspector, System Safety, Prairie and Northern Region

Mr. Corey Nordal is the Aviation Safety Officer with NAO, which is a branch of the Saskatchewan Government's Department of Environment and Resource Management known as "Saskatchewan Environment." NAOs main function is to supply aircraft for fire suppression; its fleet includes six Grumman Trackers and six CL215 tankers, along with various light twins used for Bird Dog operations and personnel transport. They have approximately 95 employees, including about 30 pilots and 35 aircraft maintenance engineers (AME).

ASL: How long have you had a safety program in place?

Corey Nordal (C.N.): We started our safety program back in about 1991, when we were a Part 604 operator, and in about 2001 we began to set up the formal safety management system (SMS). We now operate with an O.C. [operator's certificate] under Part 702 of the Canadian Aviation Regulations (CARs) and technically don't require an SMS, but since we had already established one, we decided to carry on with it.

ASL: Did you see any difference when you switched to SMS?

C.N.: No, not really, there weren't any big changes; the basic differences were the details in the reporting structure. We added some more people to our safety committee.

ASL: On your Web site there is a Safety Policy Statement, does that apply just to NAO or is that for all of Saskatchewan Environment?

C.N.: There are actually two policy statements; the first one was created as a result of the formation of our Department (Saskatchewan Environment) aviation safety committee, and it applies to the whole Department. The second one is our own policy as an air operator, and NAO adheres to both the overall policy and our own specific policy.

ASL: Where do you fit into the management structure of your branch?

C.N.: Well, as the safety officer under the old safety reporting system, I reported directly to the operations manager, but now under the new SMS I'm the secretary of the safety committee, and I report to the chief pilot with any concerns that I may have. As well, I can pass on any safety concerns that are raised by the staff to the appropriate manager. As an example, if some of the engineering staff report a concern to me, I would discuss it with the chief of engineering and the quality assurance manager. Basically I have access to all of the managers, and any of them could implement a safety recommendation that I made concerning their area of management.

ASL: If you felt at odds with the chief pilot over an issue would you be able to discuss the matter with someone else?

C.N.: Yes, I could go directly to the operations manager.

ASL: Could you tell me a bit more about the safety committee?

C.N.: The committee is made up of 15 members, including myself. Basically there is one pilot representing each of the five flight groups, and there is a representative from each of the other groups such as engineering, flight watch, air attack, trades and ground crew. The operations manager, air attack officer, chief engineer and chief pilot also sit on the committee.

ASL: How often does the committee meet?

C.N.: There are scheduled meetings every six weeks, but there could be other meetings if something comes up that requires a meeting. For example, if an incident or an accident occurs, or if something else comes up that requires a meeting, we'll gather all the information that we can and then we'll call the committee together and try to resolve that problem.

ASL: Who investigates accidents or incidents in your company?

C.N.: Myself and the quality assurance manager do the investigations. In the event of an accident, the Transportation Safety Board of Canada (TSB) would be the lead investigators and we would cooperate fully with them. For an incident, if it is aircraft-related, I usually rely on the quality assurance manager or engineering to come up with a detailed report in the matter. If it involves actual firefighting in the field, I follow up on the incident myself and interview the aircrew, or any others may be involved.

ASL: Is there a formal "safety training" for the pilots or other employees?

C.N.: Initially, when we first started the Web site and the SMS, we gave a briefing to all the staff, and now for any new employees we give them a briefing on how to use the system, who to report to and so on. The initial attack crews, fire managers and aviation managers on large fires are briefed by the person in Prince Albert, Sask., who is my counterpart on the fire management side.

ASL: Does the Internet reporting method allow for confidential reports?

C.N.: When a person files a report through the Web site, it comes directly to me, then I take the name off of the top before I send it on to anyone else. I also get back to them and let them know what happened with the report. If someone really didn't want to have their name known at all, I would act on a sheet of paper dropped off at my desk. In that case I wouldn't be able to get back to them though.

ASL: Has that actually happened, that is, have you gone through that whole cycle?

C.N.: Yes, we've had several reports go through the whole system like that.

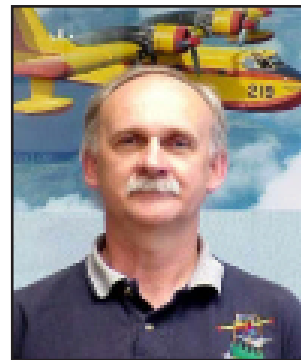



TAKE FIVE...

for safety
Five minutes reading
could save your life!



Living with Vortices

Aeroplanes and helicopters trail violent spirals of air from their wingtip or rotor

The Vortex

As a wing or rotor generates more lift, pressure differences above and below increase, putting more energy into the vortices. So...for each aircraft, increased weight means stronger vortices.

As an aircraft slows, the pressure difference above and below increases. So...as an aircraft slows, total vortex energy increases.

The position of flaps and landing gear as well as the location of engines and tail configuration all have their influence, as does twin rotor versus tail rotor helicopter configuration. So...aircraft configuration modifies the vortex pattern and persistence. And persistence is a major problem.

Since cold air is more dense than warm air, it has more "punch." So...air density influences vortex strength.

A vortex will decay with time as the swirl increases in diameter and mixes with the surrounding air. So...until the vortex collapses, it remains potentially dangerous.

As the wing or rotor moves through the air, the trailing air is thrust downwards. So...vortices descend below the flight path.



Transport
Canada

Transports
Canada

Canada

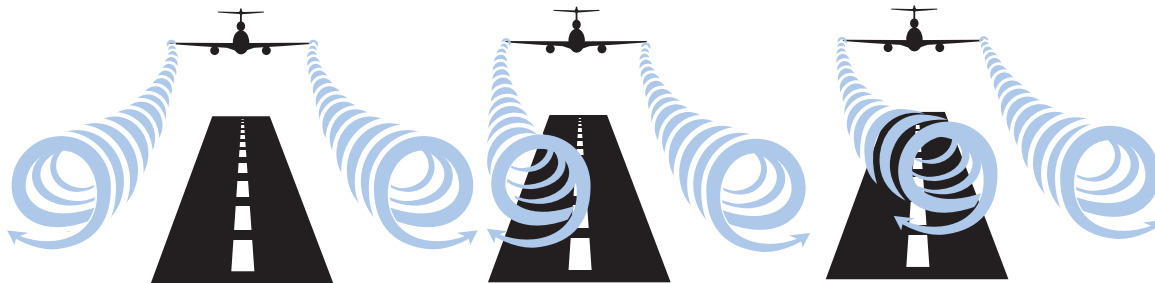

Headwinds
less than 10 kt

Light Crosswind
less than 5 kt

Crosswind
over 5 kt

Vortex movement depends on altitude...

At higher altitudes, where aircraft fly very fast, a vortex, which persists for the typical two minutes, is active as far as 16 NM behind and 1 000 ft below the aircraft.

At lower altitudes, more common to the VFR pilot, the two minutes persistence time translates into shorter distances because of the slower speeds at these altitudes.

At very low altitudes, such as during takeoff, landing, or an overshoot, vortices behave in a substantially different manner.

So, you see, the area of hazard is not necessarily aligned with the flight path of the aircraft ahead.

Safe Separation

The tower controller will provide separation for departure, depending on the weight category of your aircraft and the one ahead: ultralight, light, medium, heavy. Under some conditions, you may waive that separation. However, at uncontrolled airports and at times other than takeoff, you will have to provide your own safe spacing.

Takeoff

Plan to rotate prior to the previous aircraft's rotation point. Keep your flight path above theirs or conduct an off-centreline climb on the upwind

side. After another aircraft has landed, do not lift off until beyond the touchdown point.

Approach and Landing

Stay above the preceding aircraft's flight path, and plan your touchdown point past theirs. That means avoiding a long low final.

Around Airports

Keep a sharp lookout at all times, and listen to the radio as a guide for traffic movement. Helicopters are hard to spot, but they operate almost anywhere, and they generate vortices more violent than those of a fixed-wing aircraft of comparable weight.

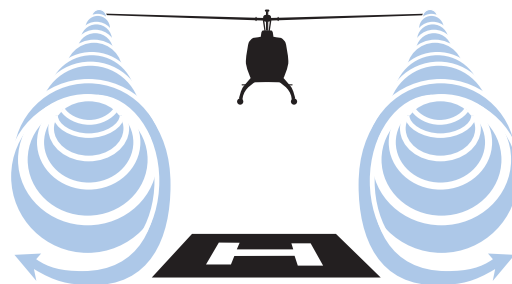

Wake turbulence is invisible only to those who cannot see it in the mind's eye. Be alert to the hazard and take the appropriate avoidance action.

This Take-5 supersedes the original brochure TP 2233E—Living With Vortices, and is available on our Web site. —Ed.